

PROFILE 1-5B
 OUTBOARD PROFILE
 3/32"=1'-0"

PRINCIPAL CHARACTERISTICS	
LENGTH OVERALL:	160'-0"
LENGTH WATERLINE:	152'-8"
BEAM OVER GUARDS:	53'-0"
BEAM WATERLINE:	39'-0"
LOADED HULL DRAFT:	7'-6"
LOADED NAVIGATION DRAFT:	9'-0"
LOADED FREEBOARD:	5'-6" AT SIDE
DESIGN DISPLACEMENT:	512 LT
PASSENGER COMPLIMENT:	150 PERSONS, 36 SEATS + 2 ADA
VEHICLE COMPLIMENT:	28 AEQs

GENERAL NOTES

1. THIS GENERAL ARRANGEMENT DRAWING IS INTENDED TO DEPICT THE LAYOUT OF THE VESSEL, CONSISTENT WITH A PRELIMINARY LEVEL OF DESIGN.

REFERENCES

1. GLOSTEN REPORT NO. 17097.02-053-02, PRELIMINARY DESIGN REPORT.

REVISIONS					
ZONE	REV	DESCRIPTION	DATE	APPD	

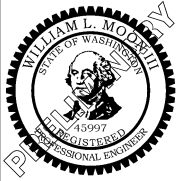

SKAGIT COUNTY PUBLIC WORKS
 MT. VERNON, WASHINGTON

GUEMES ISLAND FERRY REPLACEMENT
 GENERAL ARRANGEMENT
 STARBOARD PROFILE

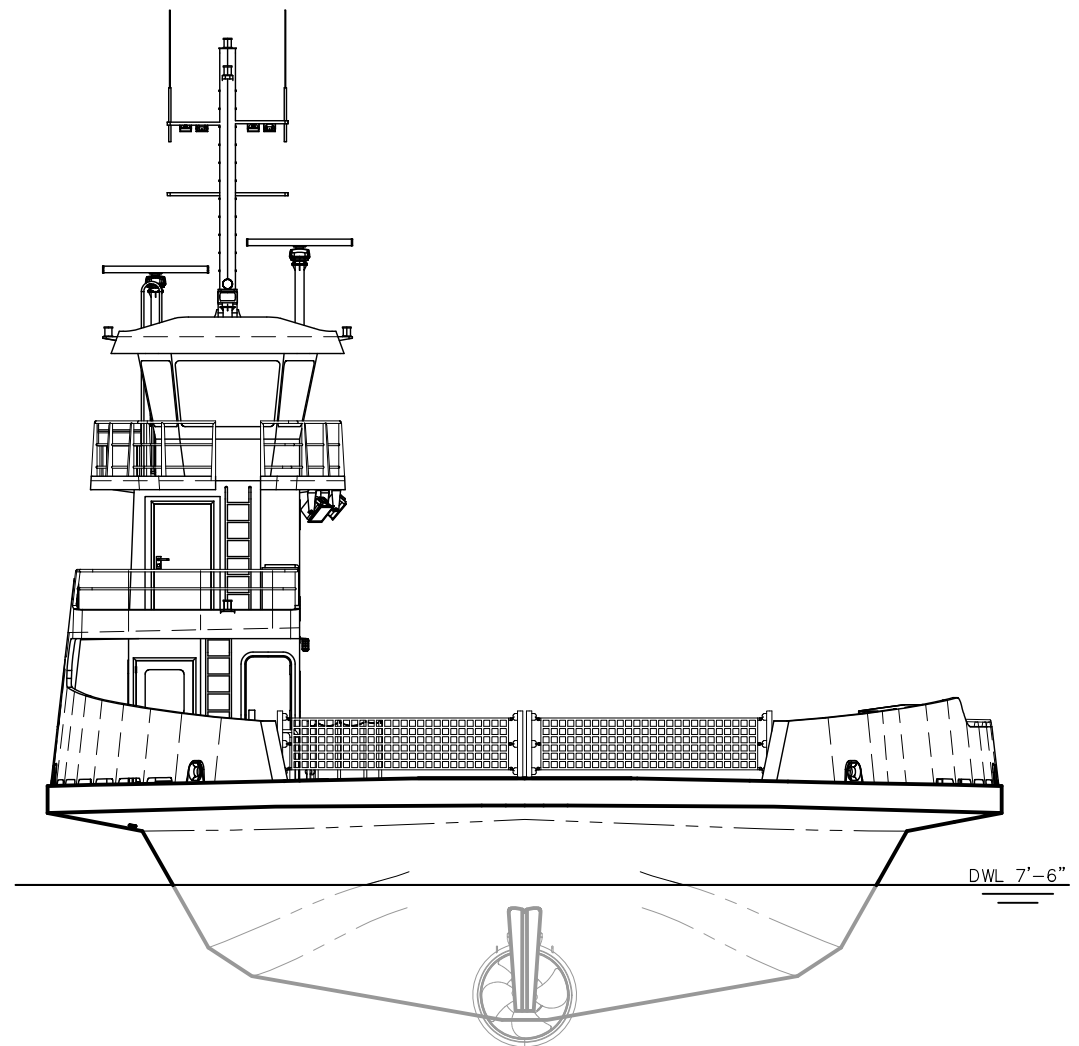

Glosten More than DESIGN. 1201 WESTERN AVENUE, SUITE 200
 SEATTLE, WASHINGTON 98101 T+1 206.624.7850 GLOSTEN.COM

Drawn JCP	Checked WLM	Approved MSM	Size B	Issue Date 2020/09/23
Scale AS NOTED	Drawing Number 17097.02-070-02	Sheet 1 of 6	Revision P1	

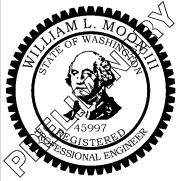

END VIEW 2-6B
 NO. 1 END (ANACORTES)
 3/32"=1'-0"

DWL 7'-6"

		SKAGIT COUNTY PUBLIC WORKS MT. VERNON, WASHINGTON			
		GUEMES ISLAND FERRY REPLACEMENT GENERAL ARRANGEMENT END VIEW			
		1201 WESTERN AVENUE, SUITE 200 SEATTLE, WASHINGTON 98101 T +1 206.624.7850 GLOSTEN.COM			
		Drawn: JCP Scale: AS NOTED	Checked: WLM Drawing Number: 17097.02-070-02	Approved: MSM Sheet: 2 of 6	Size: B Issue Date: 2020/09/23 Revision: P1

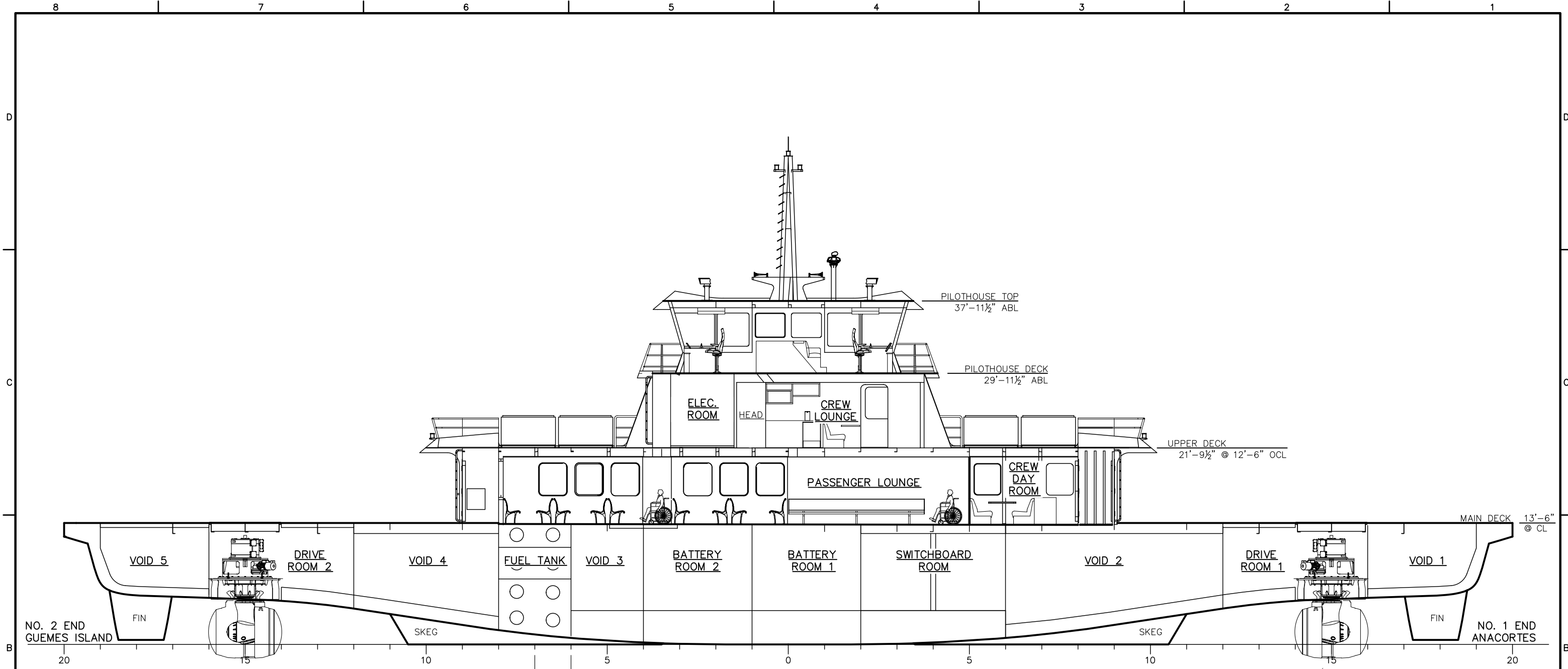

INBOARD PROFILE 3-4B
 HULL ON CENTERLINE
 HOUSE ON 16'-6" OCL
 3/32"=1'-0"

		SKAGIT COUNTY PUBLIC WORKS MT. VERNON, WASHINGTON			
		GUEMES ISLAND FERRY REPLACEMENT GENERAL ARRANGEMENT INBOARD PROFILE			
Glosten		More than DESIGN.		1201 WESTERN AVENUE, SUITE 200 SEATTLE, WASHINGTON 98101 T+1 206.824.7850 GLOSTEN.COM	
Drawn JCP	Checked WLM	Approved MSM	Size B	Issue Date 2020/09/23	
Scale AS NOTED		Drawing Number 17097.02-070-02		Sheet 3 of 6	Revision P1

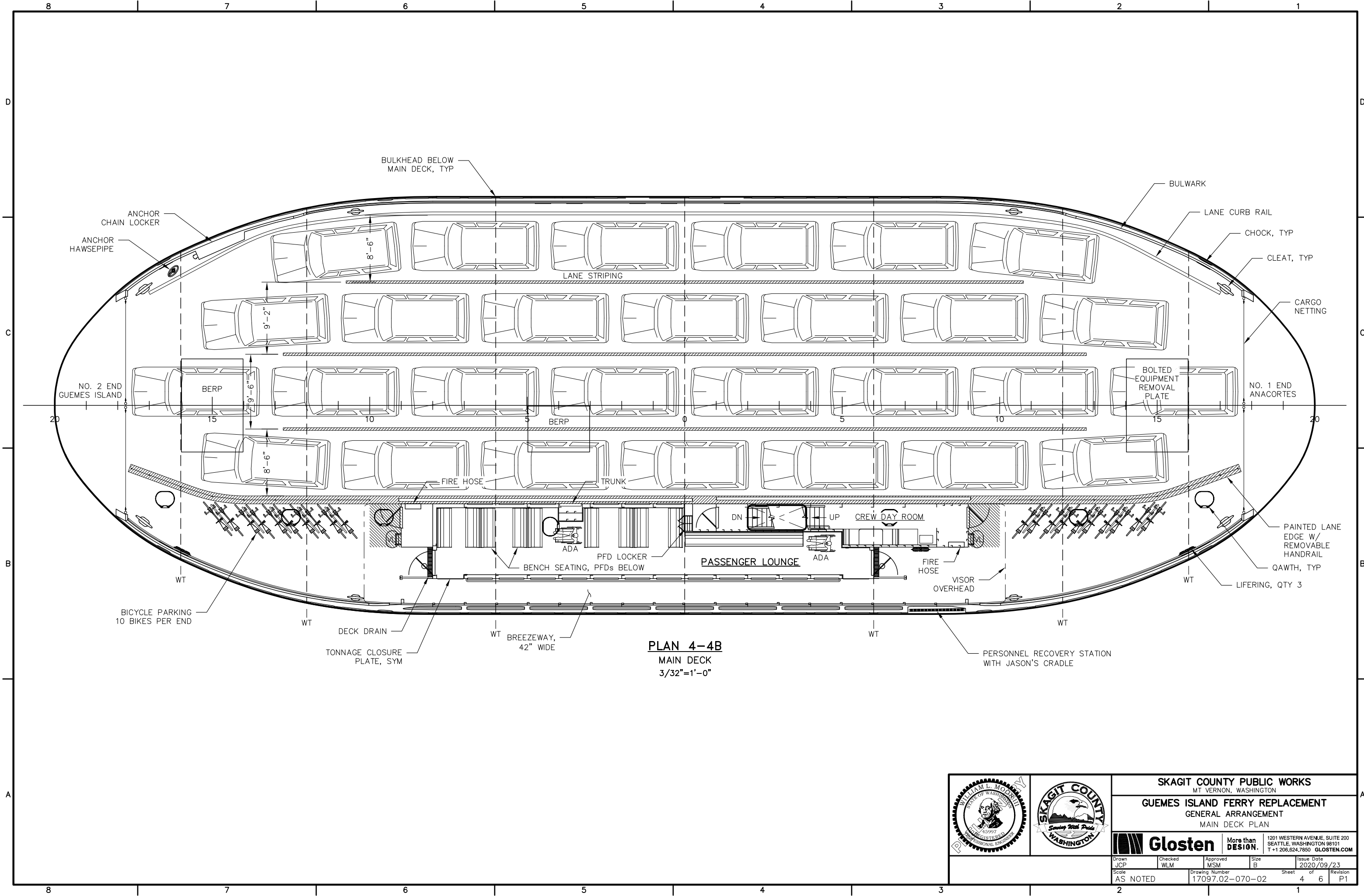

PLAN 4-4B
 MAIN DECK
 3/32"=1'-0"

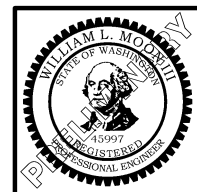

SKAGIT COUNTY PUBLIC WORKS
 MT. VERNON, WASHINGTON
GUEMES ISLAND FERRY REPLACEMENT
 GENERAL ARRANGEMENT
 MAIN DECK PLAN



Drawn JCP	Checked WLM	Approved MSM	Size B	Issue Date 2020/09/23
Scale AS NOTED	Drawing Number 17097.02-070-02		Sheet 4 of 6	Revision P1

1201 WESTERN AVENUE, SUITE 200
 SEATTLE, WASHINGTON 98101
 T+1 206.824.7850 GLOSTEN.COM

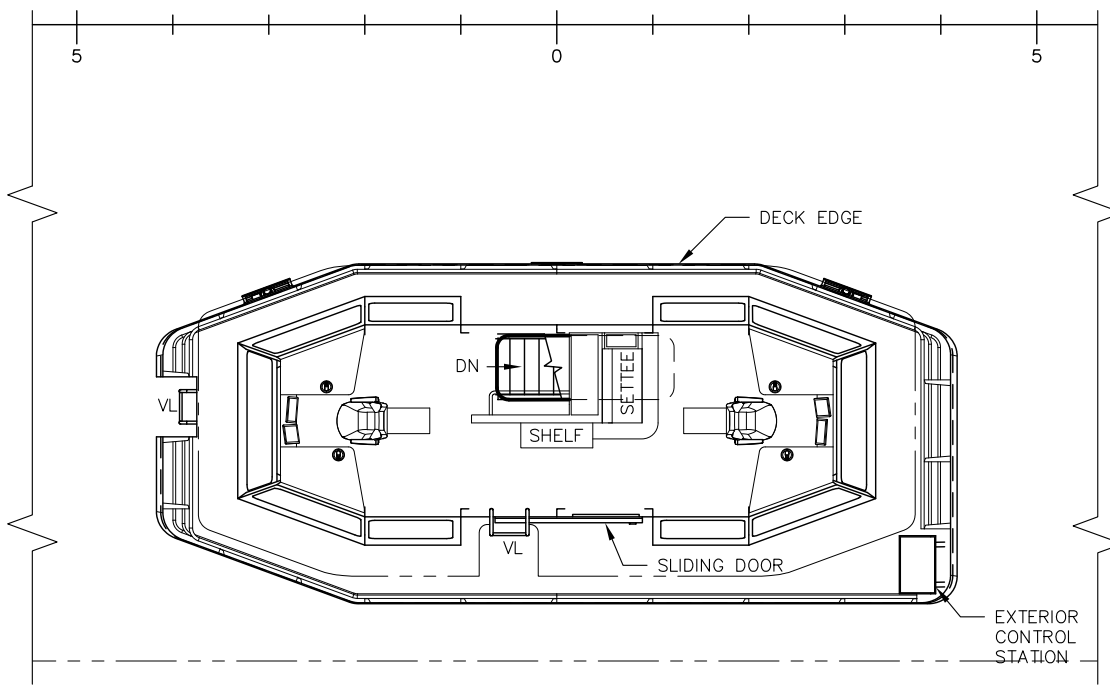

PLAN 5-6C
 PILOTHOUSE DECK, CREW ONLY
 1/8"=1'-0"

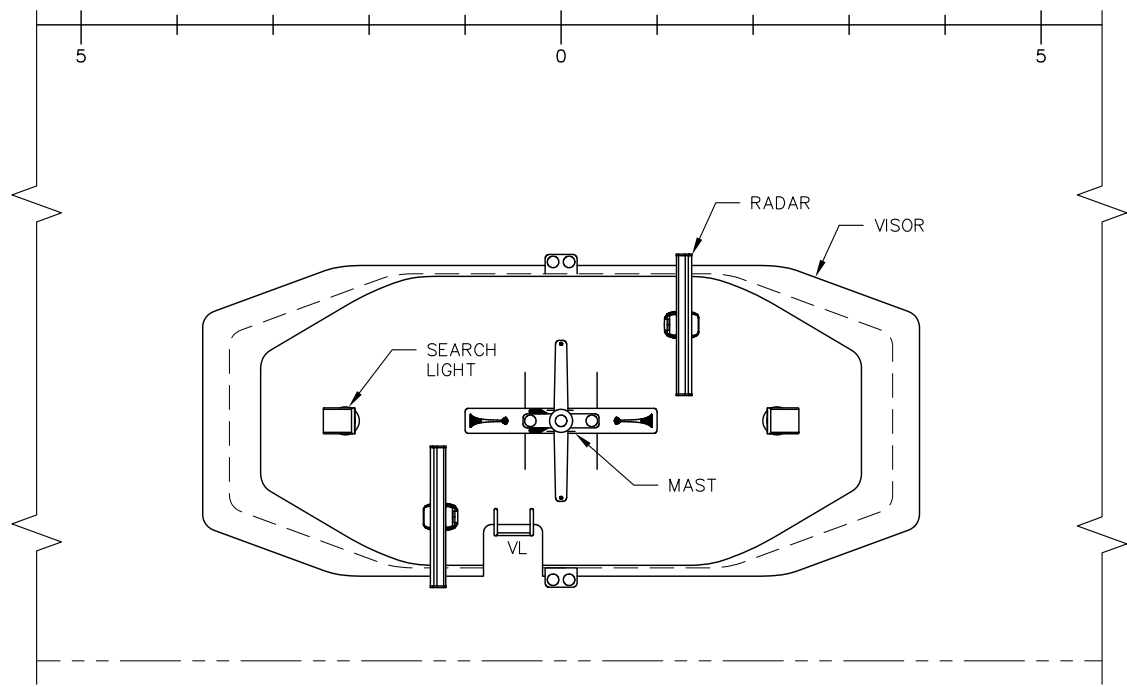

PLAN 5-3C
 PILOTHOUSE TOP, CREW ONLY
 1/8"=1'-0"

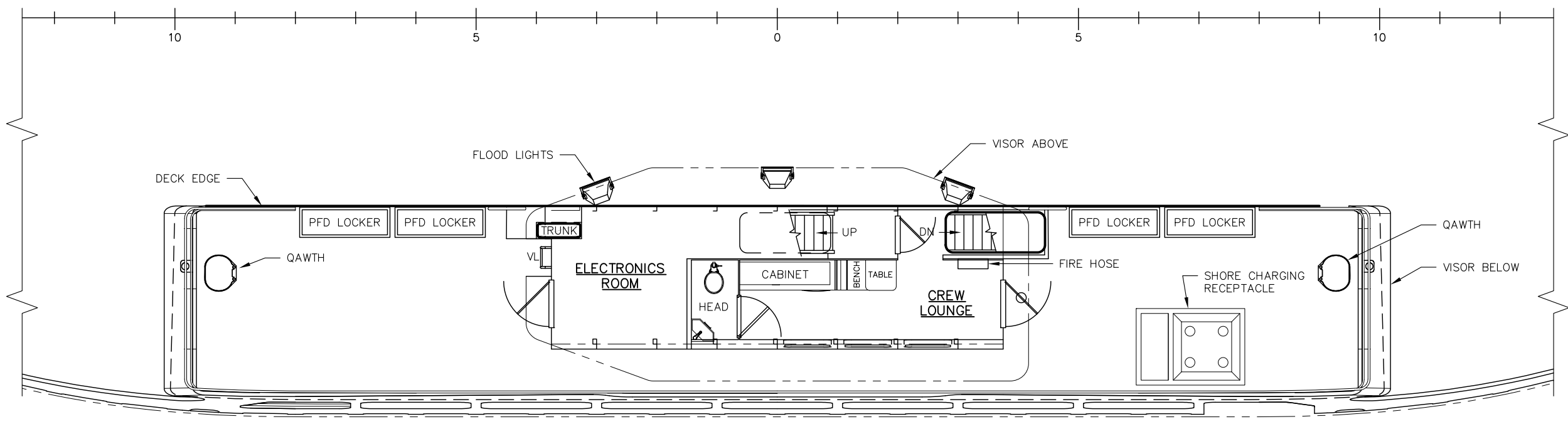

PLAN 5-4A
 UPPER DECK, CREW ONLY
 1/8"=1'-0"

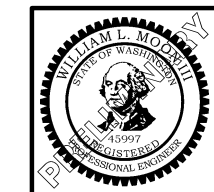

SKAGIT COUNTY PUBLIC WORKS
 MT. VERNON, WASHINGTON
GUEMES ISLAND FERRY REPLACEMENT
 GENERAL ARRANGEMENT
 UPPER DECKS PLAN

Glosten More than DESIGN. 1201 WESTERN AVENUE, SUITE 200
 SEATTLE, WASHINGTON 98101
 T+1 206.624.7850 GLOSTEN.COM

Drawn JCP	Checked WLM	Approved MSM	Size B	Issue Date 2020/09/23
Scale AS NOTED	Drawing Number 17097.02-070-02	Sheet 5	of 6	Revision P1

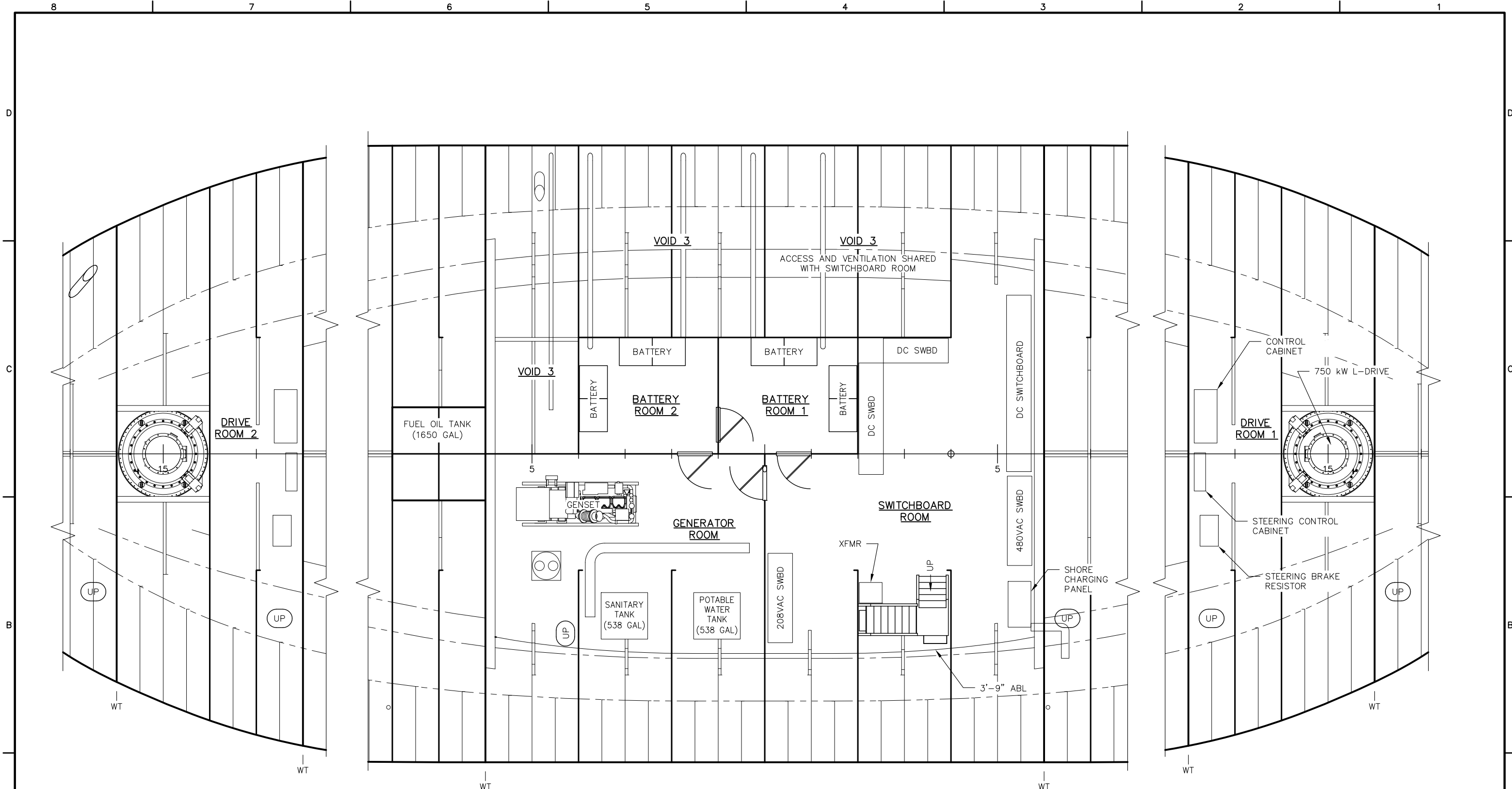

PLAN 6-5C
MACHINERY ARRANGEMENT
 1/8"=1'-0"

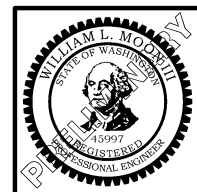

SKAGIT COUNTY PUBLIC WORKS
 MT. VERNON, WASHINGTON
GUEMES ISLAND FERRY REPLACEMENT
 GENERAL ARRANGEMENT
 HOLD PLAN & MACHINERY ARRANGEMENT

Glosten More than DESIGN. 1201 WESTERN AVENUE, SUITE 200
 SEATTLE, WASHINGTON 98101
 T+1 206.624.7850 GLOSTEN.COM

Drawn JCP	Checked WLM	Approved MSM	Size B	Issue Date 2020/09/23
Scale AS NOTED	Drawing Number 17097.02-070-02	Sheet 6	of 6	Revision P1